

Use NACHI hydraulics to save energy

Just replace your conventional hydraulic unit to our 'NSP*i*' series inverter-driven hydraulic units



Power
consumption
down by

64%

New Series

Energy-saving variable pump unit

NSP_i Series Inverter-driven Hydraulic Unit

Inverters save energy with hydraulics.

Energy savings

Energy Consumption Reduced by Approximately 64%
(compared to our standard unit while dwelling)

The base NSP unit consumes about 40% less energy than our standard unit. By adding the **inverter drive** we increase energy savings to 64% compared to our standard unit.

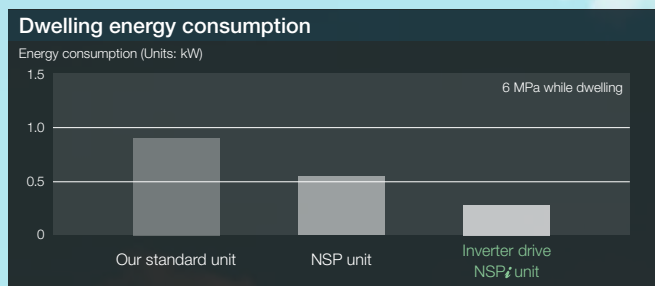

Energy costs reduced 40%

(compared to systems operating existing equipment (our estimates))

Compared to our standard unit, the NSP unit cuts about 25% and the **inverter drive** NSP_i unit cuts another 40% from energy bills.

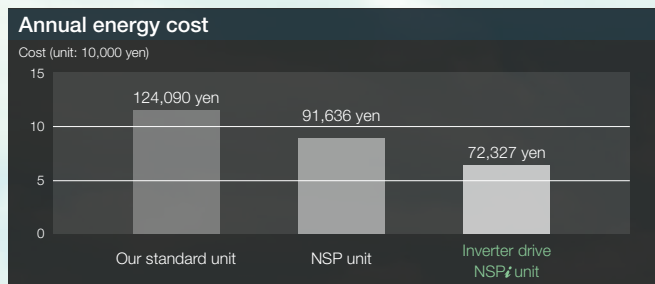

Reduces annual CO₂ emissions by two tons

The **inverter drive** NSP_i unit emits about 42% less CO₂ than our standard unit.

Equivalent to two hectares of forest

Method for calculating energy costs and CO₂ emissions

Yearly operating time	8000 hours	Energy unit cost	15 yen/kWh
Dwelling	17 hours/day	CO ₂ emissions factor	0.555 kgCO ₂ /kWh
Discharging	5 hours/day		

* CO₂ emissions factor: Default value set by Ministry of Economy Trade and Industry & Ministry of the Environment Ordinance Number 3, 2006.

Compact

Same size even with inverter drive

If you are using an NSP unit now, you can replace it without redesigning your machinery because it is almost the same size as the NSP unit. Replacing to an **inverter drive** NSP_i unit means even greater energy savings.

Replacement without machine modification is possible



10 L (tank)



20 L (tank)

• Reference
20 L type also available
(Scheduled for April)

Built-in inverter

Added **Inverter Drive** to Compact Body. Even More Environmentally Friendly and Quiet.

Reduce increase in hydraulic fluid temperature

1.5°C increase in ambient temperature

The **NSPⁱ** series benefits your entire system by lowering oil temperature to improve machining accuracy, lengthen the life of seals and hydraulic fluid, and reduce factory air conditioning costs.

Improve machining accuracy

Lengthen life of seals and hydraulic fluid

Reduce maintenance costs

Hydraulic fluid temperature increase (tank temperature - room temperature)

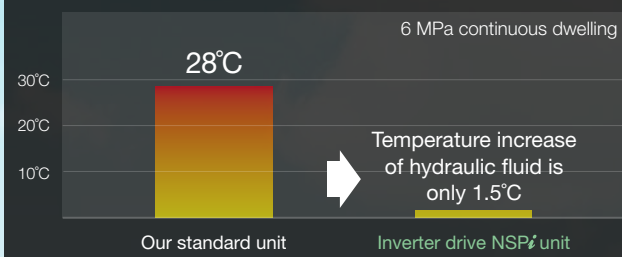

Tank size

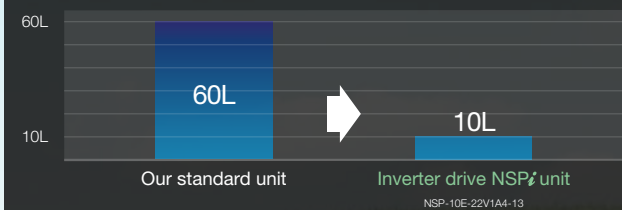

Greatly reduce the volume of hydraulic fluid

Low noise

Excellent 53 dB (A)

The noise when dwelling is as quiet as a relaxing coffee shop. The **inverter drive** saves energy and increases comfort at the same time.

(6 MPa while dwelling NSP-10E-22V1A4-20)

Easy Operation and Reliable Performance

Immediate start just by turning on the power

The **inverter drive** **NSPⁱ** unit can be started easily just by turning on the power.

Just push a single button to operate at maximum energy savings after pressure is adjusted.



Production lines keep running

Production lines continue running even if there is trouble with the inverter because it is based on our reliable **NSP** unit and keeps running as a regular **NSP** unit.

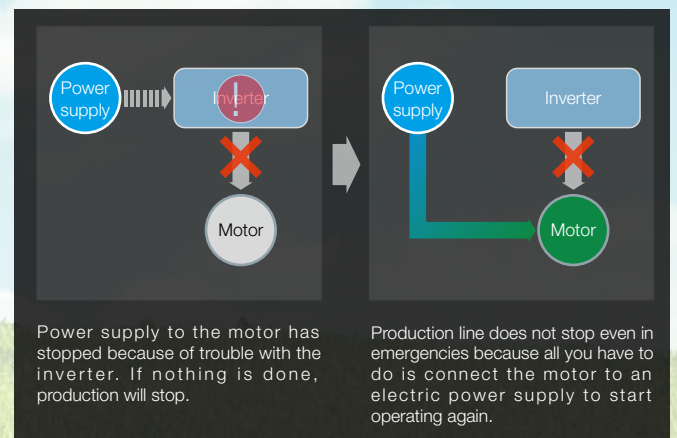

- Be careful of increases in hydraulic fluid temperature in the tank when not doing inverter energy savings operation.
- This feature is applicable only for standard 3φ AC 200/200/220V-50/60/60Hz type.

Specifications

Power supply	3 ϕ AC200~220V & 230V, 50/60Hz
Rated input current	9.7A/1.5kW, 13.4A/2.2kW
Pressure range	A2: 1.5~4.0MPa
	A3: 3.5~6.0MPa
	A4: 5.5~8.0MPa
Output flow (at no load)	0A※: 14L/min
	1A※: 28L/min
Hydraulic fluid	Standard mineral-based hydraulic fluid (equivalent to ISO VG 32)
Hydraulic fluid temperature	Use at temperatures below 60°C.
Color of paint	Munsell No. N1 (semigloss), JPMa No. AN-10 equivalent
Ambient temperature/humidity	0 to 35°C/20 to 85% RH (no condensation) (Keep the unit away from water-soluble cutting fluid mist.)

Note: Enter "X" in the optional code section if AC230V is used as the power source.
Then, AC230V type fan cooler is applied.

Explanation of model numbers

NSP-10E-※※VOA※※-※-20

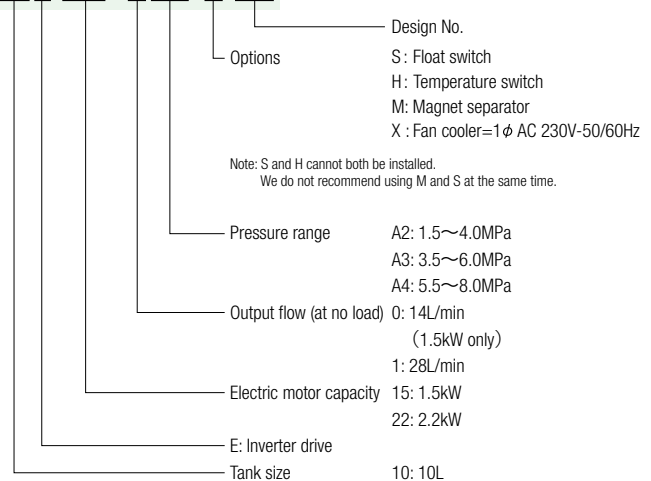

Installation dimensions

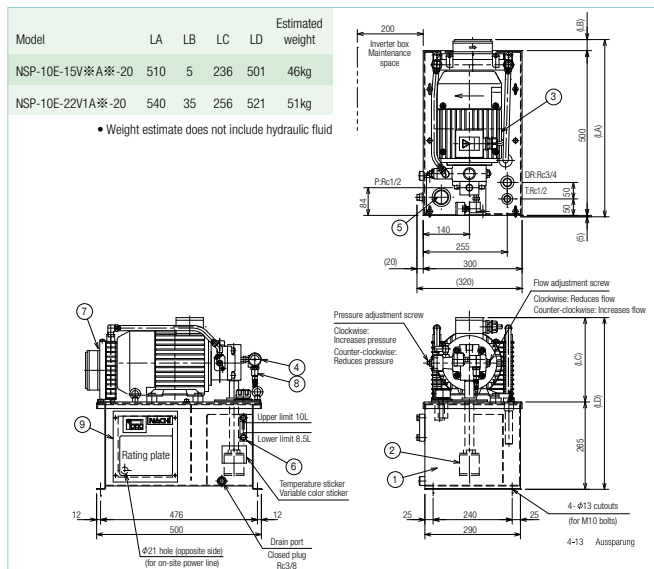

Hydraulic circuit

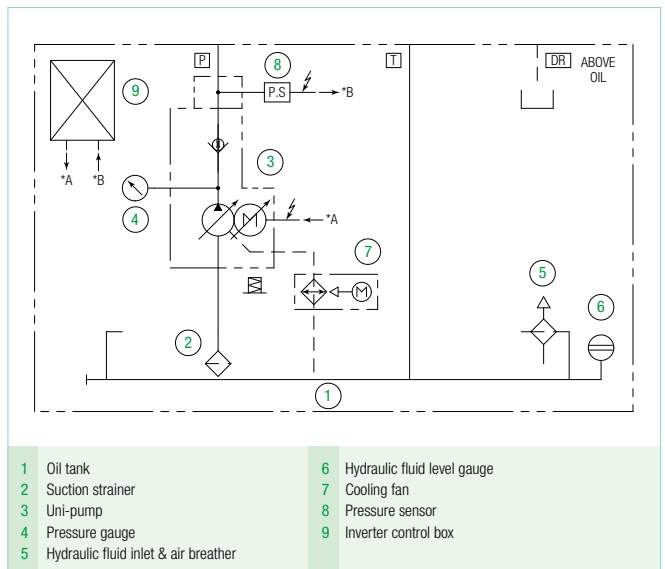

Precautions



- Turning the inverter on and off by cutting the main power supply (circuit breaker) significantly reduces the life of the inverter and should be limited to once an hour or less. Contact us if you need to start and stop operations frequently.
- Do not change the inverter's parameter settings.
- Use a 1/2 inch diameter two meter long flexible hose rated for maximum 14 MPa to connect the hydraulic unit's P port (discharge port) and the external manifold (or actuator).
- Maximum peak pressure (set pressure + surge pressure) must be within 14 MPa. Install a relief valve on the hydraulic circuit side to cut surges if peak pressure is higher than 14 MPa.
- Volume of leakage on external hydraulic circuits must be less than 1 L/min. Consult us if leakage on external hydraulic circuit is greater than 1 L/min.
- Volume of hydraulic fluid in the tank must stay within the range visible on the fluid level gage (approximately 1.5 L).

NACHI

NACHI-FUJIKOSHI CORP.

www.nachi.com

Toyama Head Office
Tokyo Head Office

Tel: 076-423-5111
Tel: 03-5568-5246

NACHI AMERICA INC. HEAD QUARTERS
NACHI EUROPE GmbH
NACHI TECHNOLOGY (THAILAND) CO., LTD.
NACHI SINGAPORE PTE. LTD.
NACHI (SHANGHAI) CO., LTD.
FUJIKOSHI-NACHI (MALAYSIA) SDN. BHD.
NACHI (AUSTRALIA) PTY. LTD.

Tel: +1-317-530-1001
Tel: +49-(0)2151-65046-0
Tel: +66-2-714-0008
Tel: +65-65587393
Tel: +86-(0)21-6915-2200
Tel: +60-(0)3-80247900
Tel: +61-(0)2-9898-1511

<http://www.nachiamerica.com/>
<http://www.nachi.de/>
<http://www.nachi.co.th/>
<http://www.nachi.com.cn/>
<http://www.nachi.com.au/>

● Specifications and configurations may change due to product developments without prior notice.

CATALOG NO. **H9241E-2**

2014.02.U-MIZUNO