

### TL (TLT) Type Feed Control Valve

(Fine Control Type With Pressure Compensation)

0.08 to 8 ℓ /min  
7MPa



TL-G0<sup>\*</sup>-\*-11

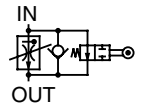

Note: 04 has DR

TLT-G04<sup>\*</sup>-\*-11

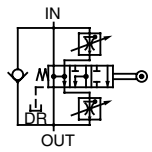

### Features

- ① Very compact, lightweight, and economically priced.
- ② Applicable for control of machine tool table operations.  
For example, a single valve provides smooth control of: Fast Feed => Cutting Feed (2 stage) => Fast Return.
- ③ Stable control of each setting flow rate, even as pressure and fluid temperature are fluctuating.
- ④ Dial markings are proportional to flow rate for simple control flow rate adjustment.
- ⑤ Sealing the gasket surface allows as-is screw-in connection.

### Specifications

Model No	Nominal Diameter (Size)	Volume control flow rate ℓ/min		Reverse Flow Rate ℓ/min	Maximum Working Pressure MPa{kgf/cm <sup>2</sup> }	Cracking pressure MPa{kgf/cm <sup>2</sup> }	Weight kg
		Feed 1	Feed 2				
TL-G03-2-11 8-11	3/8	0.08 to 2 0.1 to 8	-	35	7{71.4}	0.1{1.0}	2.2
TL-G04-2-11 8-11	1/2	0.08 to 2 0.1 to 8	-	53			7.0
TLT-G04-2-1.5-11 8-2-11		0.1 to 2 0.1 to 8	0.1 to 1.5 0.1 to 2				

#### • Handling

- ① In the temperature range of 20°C to 60°C, flow rate fluctuation is within ±5% of the standard flow rate at 40°C.
- ② In the pressure range of 1.0 to 7.0MPa {10.2 to 71.4kgf/cm<sup>2</sup>}, flow rate fluctuation is within ±5% of the setting flow rate.
- ③ Note that flow rate fluctuation exceeds the rated fluctuation amount slightly in the vicinity of the minimum control flow rate, due to changes in operating temperature and hydraulic fluid viscosity.
- ④ When controlling flow rates that are less than 0.2 ℓ /min, use with a line filter no greater than 10μm.
- ⑤ Make sure that the pressure differential between the inlet port and outlet is at least 0.6MPa {6.1kgf/cm<sup>2</sup>} at 4 ℓ /min or less, and at least 1.0MPa {10.2kgf/cm<sup>2</sup>} at 4 ℓ /min or greater.
- ⑥ The control flow rate is increased by clockwise (rightward) rotation of the control handle.
- ⑦ For connection to piping, normally connect to the sub plate. Valve mounting is gasket type, using an O-ring. When a screw in connection is required, seal the gasket surface, remove the side plug, and create a screw in connection directly to the valve unit. In this case, remove all seal material affixed to the plug.
- ⑧ See the table below for installation hex socket bolts.
- ⑨ Use the table to the right for specification when a sub plate is required.

Model No.	Pipe Diameter	Recommended Flow Rate ℓ/min	Applicable Valve Type
MTL-03-10	3/8	35	TL-G03 <sup>*</sup> -11
MTL-04-10	1/2	53	TL(T)-G04 <sup>*</sup> -*-11

- ⑩ G03 does not require drain pipe connection.
- ⑪ Cam Down Force  
TL-G03-11  
Cam Down Force  
120N {12.2kgf} minimum  
TLT-G04<sup>\*</sup>-\*-11  
Feed 1 Cam Down Force  
140N {14.3kgf} minimum  
Feed 2 Cam Down Force  
200N {20.4kgf} minimum
- ⑫ Make the cam angle no greater than 30 degrees.

Applicable Model	Bolt Size	Q'ty	Tightening Torque N·m{kgf·cm}
TL-G03 <sup>*</sup> -11	M8 × 60 ℓ	4	20 to 25{205 to 255}
TL(T)-G04 <sup>*</sup> -11	M10 × 75 ℓ	4	45 to 55{460 to 560}

Note) For mounting bolts, use 12T or equivalent.

### Understanding Model Numbers

TLT - G 04 - 2 - (1.5) - (F) - 11

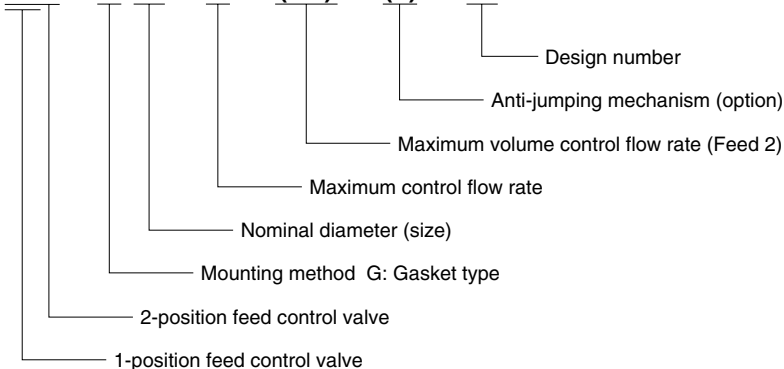

# Installation Dimension Drawings

TL-G03-\*-11

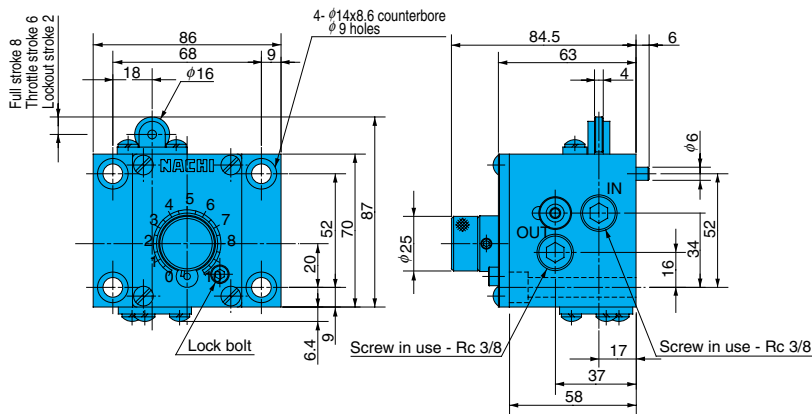

Sub Plate MTL-03-10

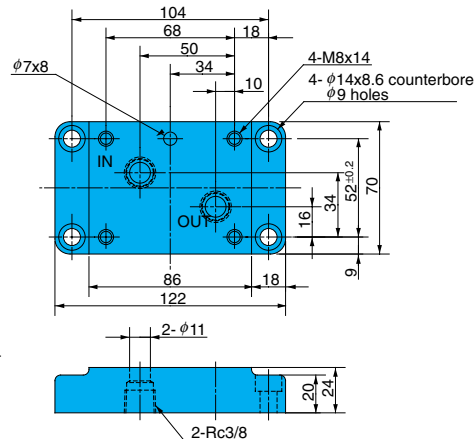

TL(T)-G04-\*-11

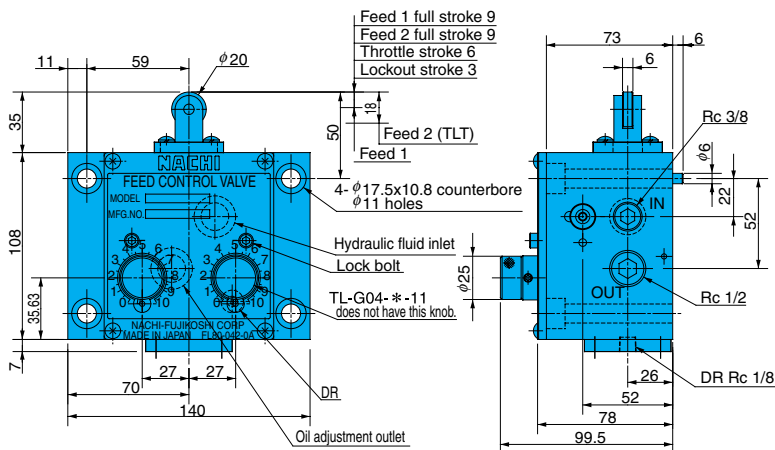

Sub Plate MTL-04-10

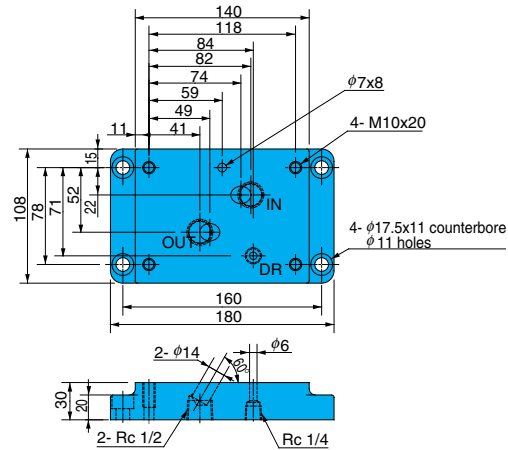

Anti-jumping Mechanism TL-G03-\*-F-11

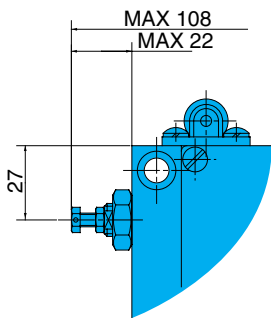

TL(T)-G04-\*-F-11

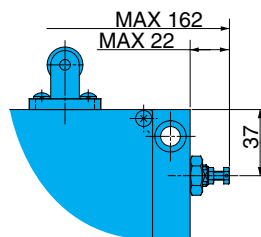

# Performance Curves

Hydraulic Operating Fluid Viscosity 32mm<sup>2</sup>/s

Fluid Temperature - Control Flow Rate Characteristics

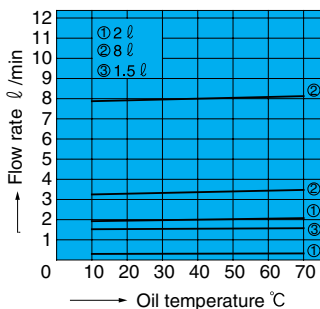

Pressure - Control Flow Rate Characteristics

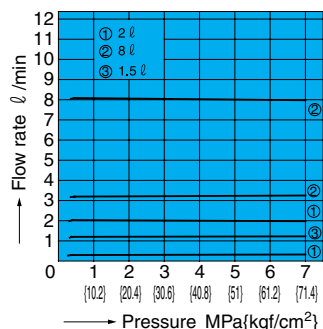

Scale - Control Flow Rate Characteristics

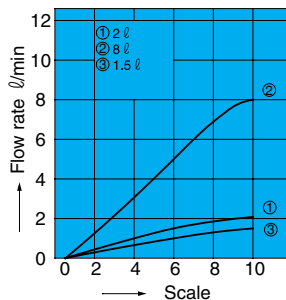

Pressure Loss Characteristics

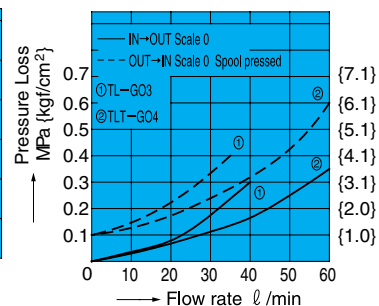

# Cross-sectional Drawing

TLT-G04-\*-F-11

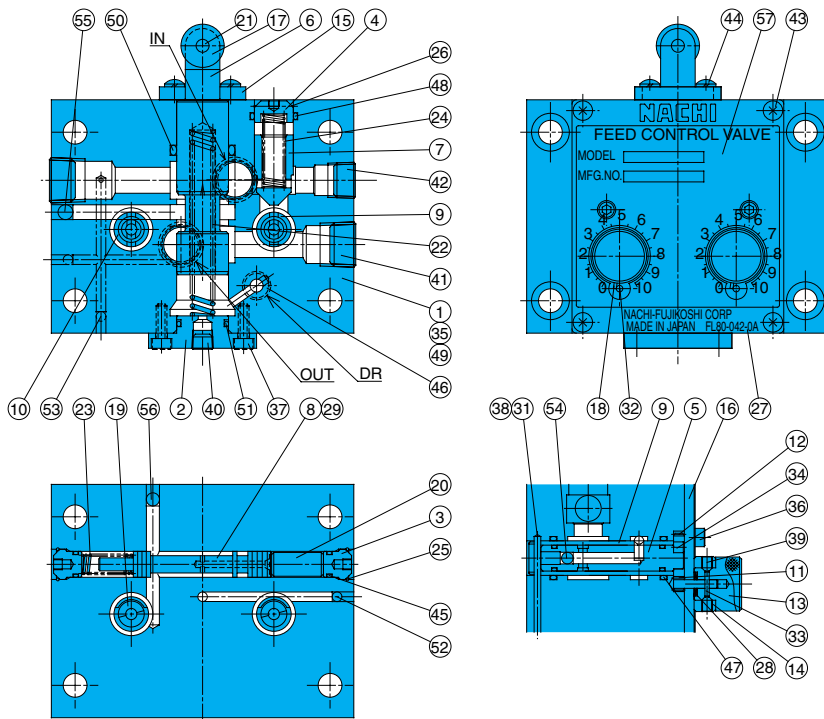

Note) The drawings on the left are TLT cross sections. In the case of TL, there is no knob on the right side.

## Anti-jumping mechanism

TL-G03-\*-F-11

TL(T)-G04-\*-F-11

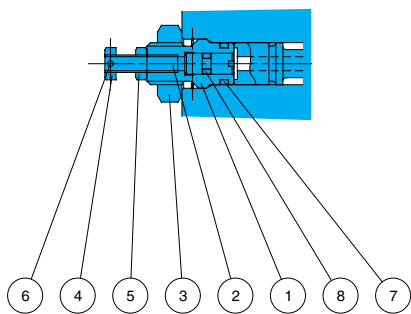

Part No.	Part Name
1	Retainer
2	Bolt
3	Nut
4	Nut
5	Nut
6	Spring pin
7	O-ring
8	O-ring

## Seal Part List

Part No.	Part Name	Part Number	Q'ty
7	O-ring	IA-P9	1
8	O-ring	IA-P3	1

Note) 1.#7 O-ring and #45 O-ring are interchangeable.  
2.O-ring 1A-\*\* refers to JIS B2401-1A-\*\*.

Part No.	Part Name	Part No.	Part Name	Part No.	Part Name
1	Body	20	Spacer	39	Screw
2	Cover	21	Pin	40	Plug
3	Plug	22	Spring	41	Plug
4	Plug	23	Spring	42	Plug
5	Throttle	24	Spring	43	Screw
6	Spool	25	Snap ring	44	Screw
7	Poppet	26	Snap ring	45	O-ring
8	Piston	27	Plate	46	O-ring
9	Sleeve	28	Washer	47	O-ring
10	Sleeve	29	Pin	48	O-ring
11	Gear	30	Pin	49	O-ring
12	Gear	31	Pin	50	O-ring
13	Knob	32	Pin	51	O-ring
14	Ring	33	Pin	52	Ball
15	Stopper	34	Pin	53	Ball
16	Plate	35	Pin	54	Ball
17	Roller	36	Screw	55	Ball
18	Pin	37	Screw	56	Ball
19	Spacer	38	Screw	57	Plate

## Seal Part List (Kit Model Number FLS-\*\*\*(2))

Part No.	Part Name	TL-G03-*-11		TL-G04-*-11		TLT-G04-*-F-11	
		Part Number	Q'ty	Part Number	Q'ty	Part Number	Q'ty
45	O-ring	IA-P9	4	IA-P9	4	IA-P9	6
46	O-ring	-	-	IA-P10	1	IA-P10	1
47	O-ring	IA-P16	2	IA-P16	2	IA-P16	4
48	O-ring	IA-P14	1	IA-P18	1	IA-P18	1
49	O-ring	IA-P14	2	IA-P20	2	IA-P20	2
50	O-ring	IA-P18	2	IA-P24	1	IA-P24	1
51	O-ring	-	-	IA-P20	1	IA-P20	1

Note) 1.\*\*\* in the kit number is used for specification of the valve size. To specify TLT, add 2 to the end.  
2.O-ring 1A-\*\* refers to JIS B2401-1A-\*\*.